

SPECIFICATIONS

Size	Metric	British
Max. Working Height	26.30m	86ft 3in
Max. Platform Height	24.30m	79ft 9in
Max. Operating Range(+0.6m)	19.40m	63ft 8in
Max. Platform Range	18.80m	61ft 8in
Flatbed Transport Dimensions(L×W×H)	7.95m×2.50m×2.96m	26ft 1in×8ft 2in×9ft 8in
Standard Container Transport	All Applicable	All Applicable
Platform Size(Length×Width)	2.44m×0.91m	8ft×3ft
Turntable Tailswing	1.61m	5ft 3in
Ground Clearance A	0.41m	1ft 4in
Wheelbase B	2.80m	9ft 2in
Turning Radius(Inside/Outside)	1.87m/3.22m	6ft 2in/10ft 7in
Tyres	385/45-28	385/45-28

Performance		
S.W.L	454kg	1000lb
Max. Occupants	3	3
Gradeability	30%	30%
Travel Speed(Stowed)	6.0km/h	3.7mph
Travel Speed(Raised)	1.1km/h	0.7mph
Max. Working Slope	X-5°/Y-5°	X-5°/Y-5°
Turret Rotation	360°Continuous	360°Continuous
Platform Rotation	180°	180°
Jib Movement	135°	135°

Weight		
Overall Weight	16090kg	35472lb

Power		
Lithium Battery	420Ah/80V	420Ah/80V
Emergency Power System	12V	12V
Driving Motor	54VAC/18kW	54VAC/18kW
Hydraulic Tank	165L	43gal

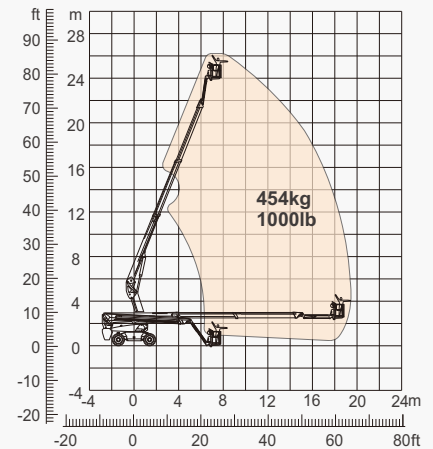

Range Of Motion

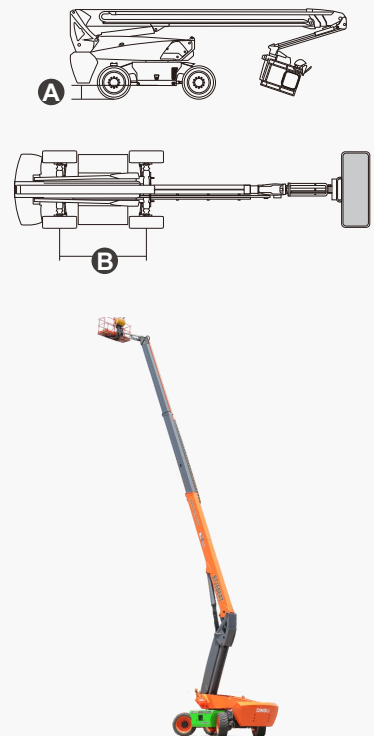

FEATURES

Standard Items

- 2.31m(7ft 7in) Jib
- Front Oscillating Axle
- Four-Wheel Steering
- Four-Wheel Drive
- Self-Leveling Platform
- 180° Left And Right Swing Platform
- Proportional Joystick Controls
- Thumb Rocker Steer
- Drive Enable
- Ac Power Cord To Platform
- Tilt Alarm
- Descent Alarm
- Flash
- Horn
- Hour Meter
- Integral Integrated Special Drive Axle
For Construction Machinery
- 360° Continuous Turntable Rotation
- Positive Traction Four Wheel Drive
- Platform Load Sense System
- Fault Diagnosis System
- Operator Anti-crushing Protection System
- Harsh Environment Kits
- 12V DC Auxiliary Power
- Lithium Battery 420Ah/80V
- Driving Motor 18kW 3243rpm
- Lifting Motor 24kW 2150rpm



Telescopic
Boom-BT



Working
Height-26m



Barb Jib-B



Electric-E



Rough
Terrain-RT



454kg-Heavy Load

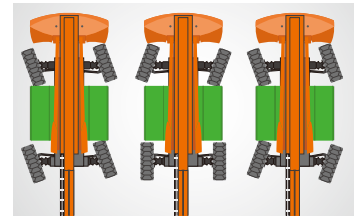

Multiple Steering Modes



Anti Extrusion Device



Barb Jib

DINGLI AWP INDIA PRIVATE LIMITED

Address: Sahney Towers, 81, First Floor, Poonamallee High Road, Nerkundram,
Chennai, Tamil Nadu - 600 107
Telephone: +91-98846 48464
E-mail: support@dinglisaarc.com
Website: <https://dinglisaarc.com>

